

The GENERAL RADIO EXPERIMENTER

VOL. X. No. 7



DECEMBER, 1935

ELECTRICAL COMMUNICATIONS TECHNIQUE AND ITS APPLICATIONS IN ALLIED FIELDS

THE NEW MODULATION MONITORS

THE Federal Communications Commission, recognizing the importance both to broadcasters and to the

public of operating every broadcast channel at a high efficiency, has for several years required that all transmitters be capable of satisfactory operation at a modulation level of at least 75%. By a

recent amendment to Rule 139 the Commission now requires that transmitters shall be capable of the still higher efficiency possible with the recent advances in design, and that means shall be available for continuously checking the modulation percentage. The amended Rule 139 says in effect:

(a) That all broadcasting transmitters shall be capable of delivering authorized power with a modulation of at least 85%; and that the total

audio-frequency distortion generated by the transmitter at this level shall be not over 10%.

(b) That all stations shall have an approved modulation monitor.

THE recent amendment of Rule 139 by the Broadcast Division of the Federal Communications Commission is of vital interest to everyone connected with radio broadcasting. This article discusses the specifications covered by Section (d) of Rule 139 from the viewpoint of the broadcasting station engineer and operator.

According to the Commission's specifications, approved monitors must include a means by which the percentage of modulation can be continuously and

easily read at all times, and must be equipped with an over-modulation alarm signal.

The purpose and usefulness of the monitor are immediately apparent. By its use station operators can maintain the highest possible modulation consistent with good broadcast practice, and, when modulation exceeds the capability of the transmitter, the alarm flashes a warning. A reasonable balance between inefficient under-modulation and distorted over-modu-

lation is thus made possible. These characteristics are discussed more in detail later in this article.

Early in 1931 the General Radio Company placed on the market one of the first commercial modulation meters, the TYPE 457. This instrument was accurate, simple to operate and for the first time provided a means for easily determining modulation percentage without elaborate testing equipment. It was, however, a balance-operated device, not direct reading, and good only for steady-state conditions of modulation. The present need is for a direct-reading instrument which will follow accurately the rapid fluctuations resulting from voice or music modulation of the broadcast transmitter. The TYPE 731-A Modulation Monitor* has been developed to meet this need.

The first considerable number was installed in April, 1935, in the owned and affiliated stations of the Columbia Broadcasting System as a part of the complete CLASS 730-A Transmission Monitoring Assembly. The field trials thus obtained were of great assistance in determining how these instruments, and particularly the modulation monitors, worked out in practice in representative stations.

The transmission monitoring assembly not only provides the means for maintaining a continuous monitor of modulation percentage, but also for measuring the total harmonic distortion and the residual noise level of the transmitters. The modulation monitor is, of course, entirely self-contained and not dependent upon the other units in the assembly.

The Federal Communications Commission has specified in detail the electrical requirements of a suitable monitor. These requirements are met exactly by the General Radio TYPE 731-A Modulation Monitor.

The specifications are the result of a long study of the problem. In order to obtain the various viewpoints, the Commission held several conferences which were attended by engineering representatives of many operating companies and manufacturers. As a result of this study of the monitoring requirements of the broadcasting station, the final specifications were drawn, taking into consideration that the monitor as an instrument had to be simple in operation, accurate, and not expensive.

The important features which the monitor must provide are:

- (1) A d-c meter for setting the average rectified carrier.
- (2) A peak indicating light which flashes on all peaks exceeding a predetermined value set at will by operator.

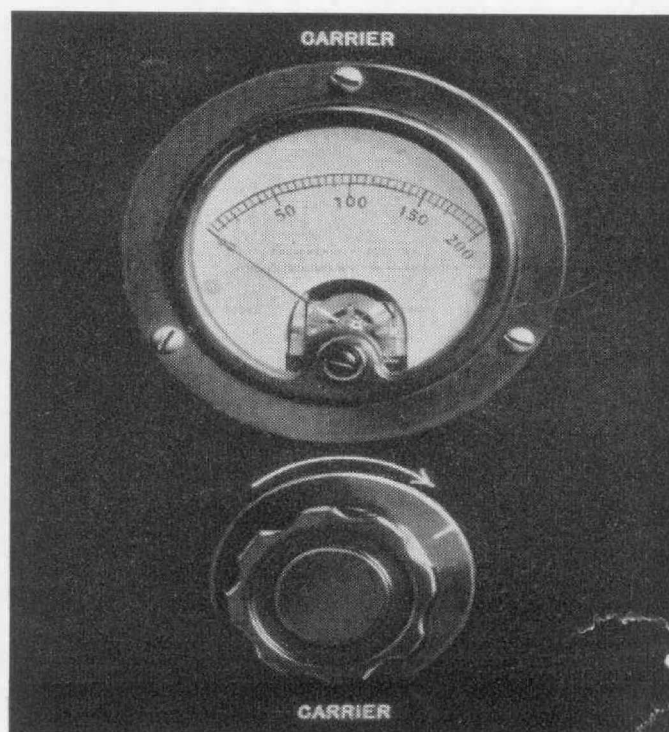

* Monitoring of Broadcasting Stations, L. B. Arguimbau, General Radio *Experimenter*, IX, 8 and 9, January and February, 1935.

(3) A meter indicating continuously the percentage modulation.

The d-c meter has two functions: first, it provides a means for indicating the reference carrier level at which the monitor is to operate and, second, it shows carrier shift during modulation, which is a warning of inequalities in positive and negative peaks, with the resulting probability of distortion.

The flashing light operates when the modulation exceeds any percentage that has been pre-set by the operator. The setting of the level of modulation above which the lamp flashes is determined by the modulation capability of the transmitter and by the type of program. It is set to flash with moder-

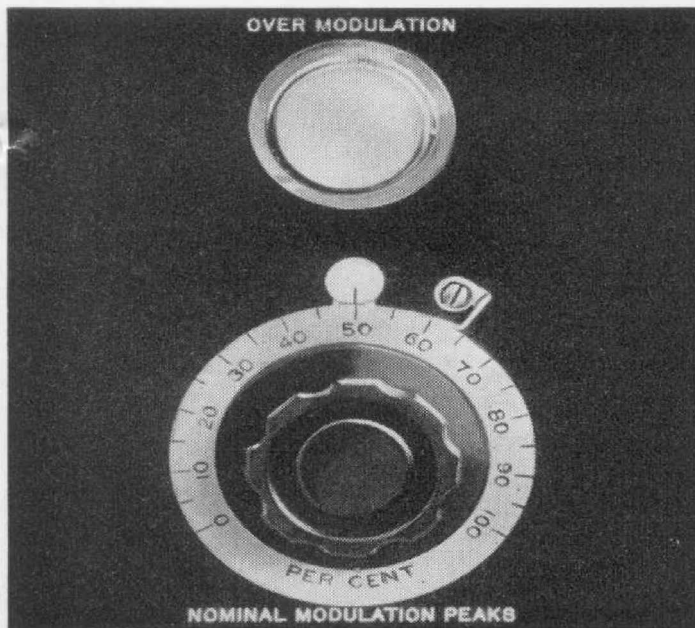
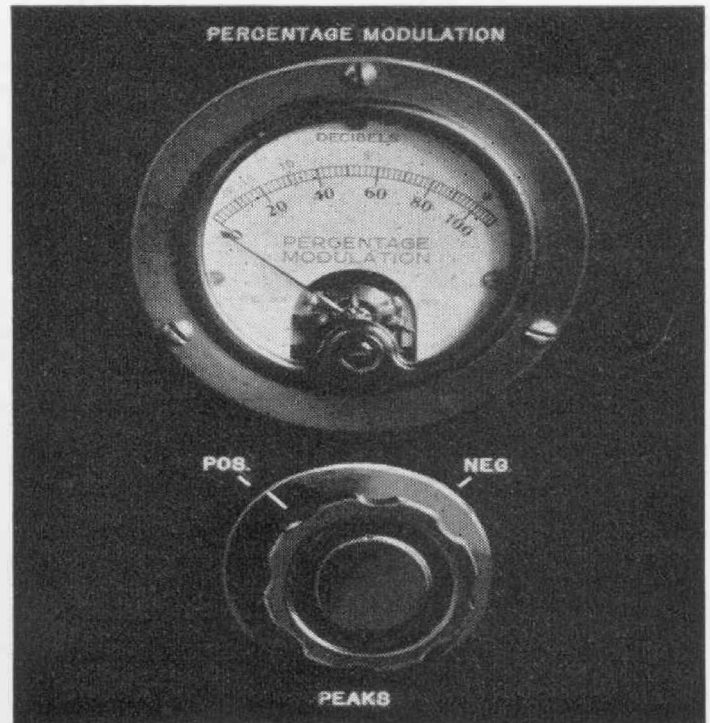

ate frequency while things are functioning normally. This is usually at a level of about 85% or higher. After a little experience, the normal rate of flash to be expected from any particular class of program material becomes familiar to the operators.

When used at first in conjunction with a monitoring loudspeaker, a surprising facility of modulation level

maintenance is developed by the use of the light alone. If, without a change in program, the rhythm of the flashes is markedly changed, the operator is immediately warned that something is wrong. If the flash rate slows down or stops, the modulation level has dropped too low, and if the light flashes continuously or not in synchronism with the loudspeaker monitor, trouble has developed in the transmitter. Since the light is visible at some distance, close attention to the monitor is not required. An electrical counter may be attached to provide a record of the number of over-modulation flashes occurring in a given period.

The third requirement is a meter which reads the actual percentage of modulation at all times. It can be switched to read either the positive or the negative modulation percentage. The meter has the new high-speed movement and is about critically damped. It reaches full-scale deflection in about 100 milliseconds with almost no overswing, and returns to zero in

about the same time. If used directly on voice or music programs this high-speed movement would follow the rapidly changing levels faithfully, but its speed is so great that accurate monitoring would be difficult, and it would be rather tiring to watch it for any length of time, especially for those who are used to the lazy movement of the older volume indicator meters.

To avoid this it has been specified that the circuits of the monitor must be arranged so that, when a pulse of modulation between 40 and 90 milliseconds in duration occurs, it is stored electrically until the meter can reach 90% of its steady-state deflection. It is not desirable that shorter pulses show so prominently on the meter as these short bursts do not contain enough energy to be bothersome in case of over-modulation. The electrical circuit stores the pulse and then discharges rather slowly, the time for the meter to return from full scale to 10% of full scale being specified as between 500 and 800 milliseconds (it is 700 milliseconds in the TYPE 731-A Modulation Monitor). The result is a meter action which goes up extremely rapidly with modulation peaks and returns relatively slowly. This action has been selected for several reasons:

(a) A high-speed meter movement without the retarded return speed is rather difficult to follow by eye and soon results in fatigue, as mentioned previously.

(b) Monitoring is greatly facilitated when the meter stays at its top reading for a short time so that the peaks can be read.

(c) There is the feeling by observers that the meter reading corresponds with the sound heard by ear. This is a psychological effect and, although not of great importance, assists in monitoring. The dual-speed action (fast-up, slow-return) gives the impression that the monitor is following the peaks of the envelope of the modulation, and, in fact, it is registering faithfully the important modulation peaks as they occur, and the "floating" reading makes monitoring relatively a simple matter.

An additional requirement specifies that the monitor must have an extremely good audio-frequency characteristic (± 0.5 db from 30 to 10,000 cycles). This permits accurate measurements to be made of the over-all frequency response of a transmitter.

The foregoing paragraphs discuss the principal features of the specifications for modulation monitors as pub-

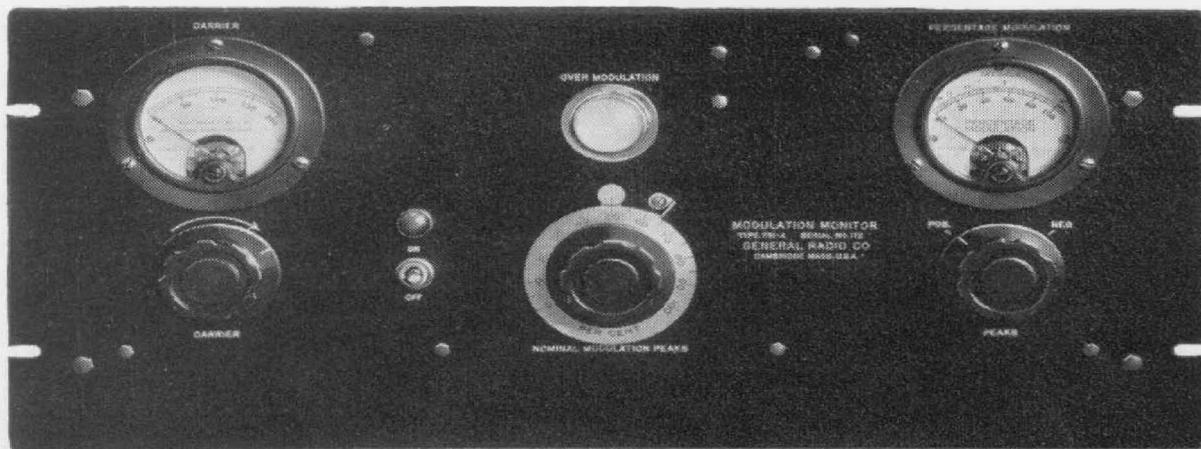

Panel view of TYPE 731-A Modulation Monitor

lished by the Federal Communications Commission in a letter dated October 29, 1935, supplementing the new amended Rule 139.

All monitors to be approved by the Commission are first carefully checked by the Bureau of Standards. At the

time of our going to press the Bureau was not prepared to begin these tests, but, when the test set-ups are ready, a stock model of the General Radio modulation monitor will be submitted for test in order to obtain formal approval. —ARTHUR E. THIESSEN

Specifications for the TYPE 731-A Modulation Monitor will gladly be sent on request. A limited number of instruments are available for immediate delivery. Orders will also be accepted with delivery contingent upon approval by the Federal Communications Commission.

Type	Code Word	Price
731-A Modulation Monitor*	EXIST	\$195.00

* This instrument is manufactured and sold under the following U. S. Patents and license agreements:
 Patent No. 1,999,869
 Patent No. 2,012,291
 Patent Applied For.



A NOTE ON THE MEASUREMENT OF METER SPEEDS

THE measurement of meter speed in the new modulation monitor presents an interesting problem. Photographing the action of the meter with a high-speed camera and a stroboscopic light source is a satisfactory method.

The plots of Figure 1 and Figure 2 were made from data obtained from this type of motion picture record. In order to compare accurately the motion of the pointer with the duration of the pulse, the modulation meter and

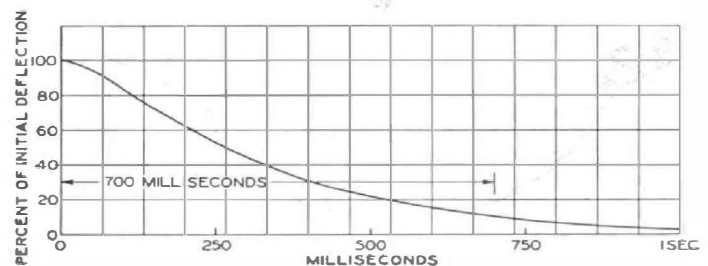
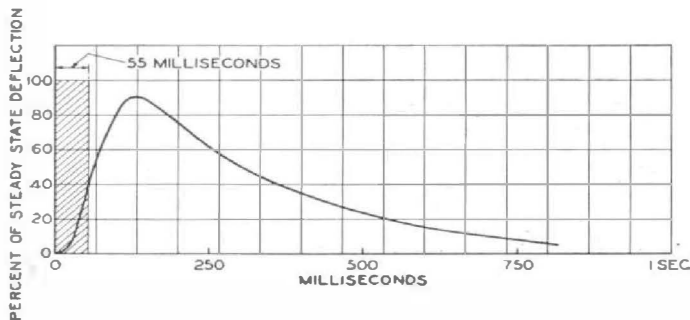

FIGURE 1 (left). Plot of meter deflection vs. time when a pulse of 55 milliseconds duration is applied. The pulse length is just sufficient to bring the meter to 90% of its steady-state reading on a pulse of the same amplitude. Note that the meter does not reach its maximum deflection until after the end of the pulse

FIGURE 2 (right). Deflection vs. time plot showing the meter returning to zero. The time required for the meter to return to 10% of its initial reading is 700 milliseconds

a cathode-ray oscillograph were set up side by side, and the pulse applied to the meter was used to deflect the oscillograph beam. Flashing the stroboscope lamp at a speed of 60 per second gave a sufficiently complete record. From Figure 3, which shows a section of film, it will be noted that the trace on the cathode-ray tube is recorded contin-

uously, while the meter is photographed at intervals of $1/60$ th second.

FIGURE 3. A section showing two frames of the motion picture record. The order of progression is from top to bottom. The oscillogram is recorded continuously while the meter is photographed at intervals of $1/60$ th second by means of the stroboscopic flash. The index mark was placed opposite the spot on the cathode-ray tube and indicates the position of the spot at the instant each photograph is taken. When the oscillogram becomes a straight line, showing the end of the pulse, the meter has not yet reached its maximum reading. This is shown graphically in Figure 1. In this photograph the oscillogram has been retouched to make it suitable for halftone reproduction

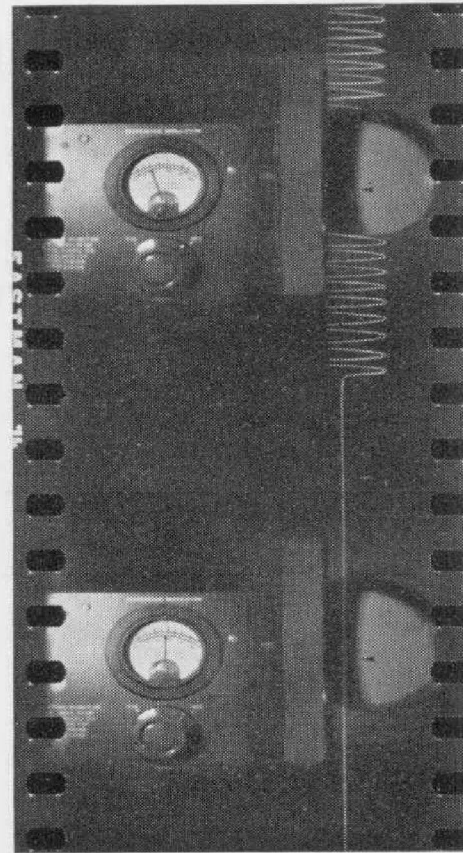

A DIRECT-INDICATING AUDIO-FREQUENCY METER

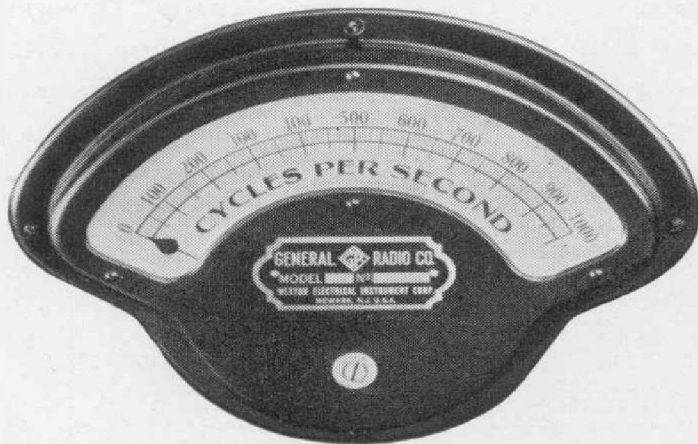

A DIRECT-INDICATING audio-frequency meter is a great convenience in many laboratory measurements, or in production and testing operations where a large number of measurements must be quickly made. In some cases, a continuous indication

of the value of a varying frequency is required. To meet these requirements, the TYPE 834-A Electronic Frequency Meter has been developed. This instrument is of radically new design, is direct reading from zero to 5000 cycles per second, and operates from the a-c line.

The meter consists, essentially, of an amplifier, a gas-discharge-tube counter, and an indicator. The fundamental circuit design of the instrument was devised by Dr. F. V. Hunt.*

Figure 1 is a schematic diagram showing the important circuit elements. A detailed explanation of the operation of the circuit will be found in a recent

* Craft Laboratory, Harvard University.

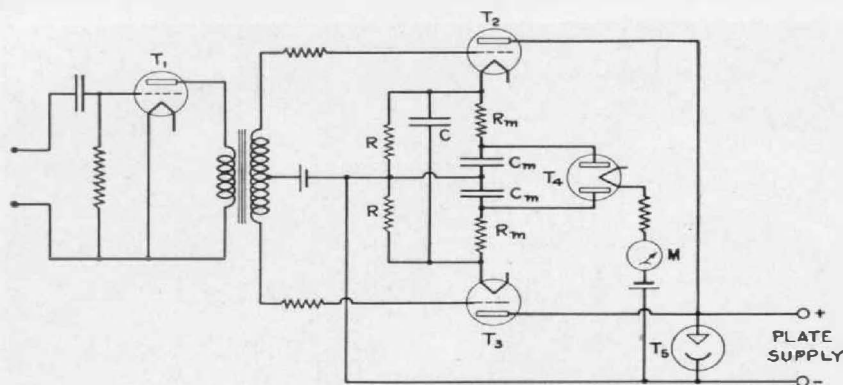

FIGURE 1. Schematic circuit diagram of the electronic frequency meter. For convenience, batteries are shown supplying the grid and meter biases. T_1 is an amplifier, T_2 and T_3 are gas-discharge tubes; T_4 is a double diode, and T_5 a voltage regulator. The circuits R , C , control the voltage on the grids of the gas-discharge tubes; the circuits R_m , C_m , control the action of the double diode

article† by Dr. Hunt published in the Review of Scientific Instruments.

The principle of operation is, briefly, as follows: On the application of an alternating voltage to the grids of the gas-discharge tubes, the tubes become alternately conducting and non-conducting. At each *transition* of the current from one tube to the other, a single, short current pulse is sent through the indicator circuit. As the successive current pulses are identical, the meter reading will depend only on the number of pulses per second, or the frequency.

The instrument includes a one-stage amplifier, the gas-discharge-tube counter circuit, diode switching tube, frequency-indicating meter and power supply (with rectifier and voltage regulator).

The amplifier provides for satisfactory operation on signal inputs of three volts or less, and also provides a high impedance input circuit (one megohm). By the arrangement of the amplifier circuit, provision is made for satisfactory operation over a wide range of signal input voltages, up to 200 volts, with no change in indication of frequency.

Five ranges are provided, each starting at zero and extending to 200,

500, 1000, 2000, and 5000 cycles. The desired range is selected by means of a multiplier switch mounted on the panel. Individual adjustments are provided for making the indication agree with the scale of the meter on each range. These adjustments are made at the factory, but, if necessary, readjustment may be made in the field. All adjustments are accessible from the panel, which is intended for mounting in a 19-inch relay rack.

The TYPE 834-A Electronic Frequency Meter is a time-saving aid in frequency measurements, such as the routine checking of a large number of radio transmitters. Generally, in such cases, the first question to be answered is: "Is the station frequency within the allowed tolerance?" and second, "How much does the station frequency deviate from the assigned value?" Both questions may be answered by the meter, but, having answered the first, often no further attention need be given to those stations falling well within the allowed tolerance.

In crystal grinding and similar adjustment operations, the indications of the frequency meter provide a continuous check on the progress of the adjustment — indicating when coarse adjustment is safe and also indicating when fine adjustments must be made to obtain the final desired

† A Direct-Reading Frequency Meter Suitable for High-Speed Recording, *Review of Scientific Instruments*, 6, 2, January, 1935.

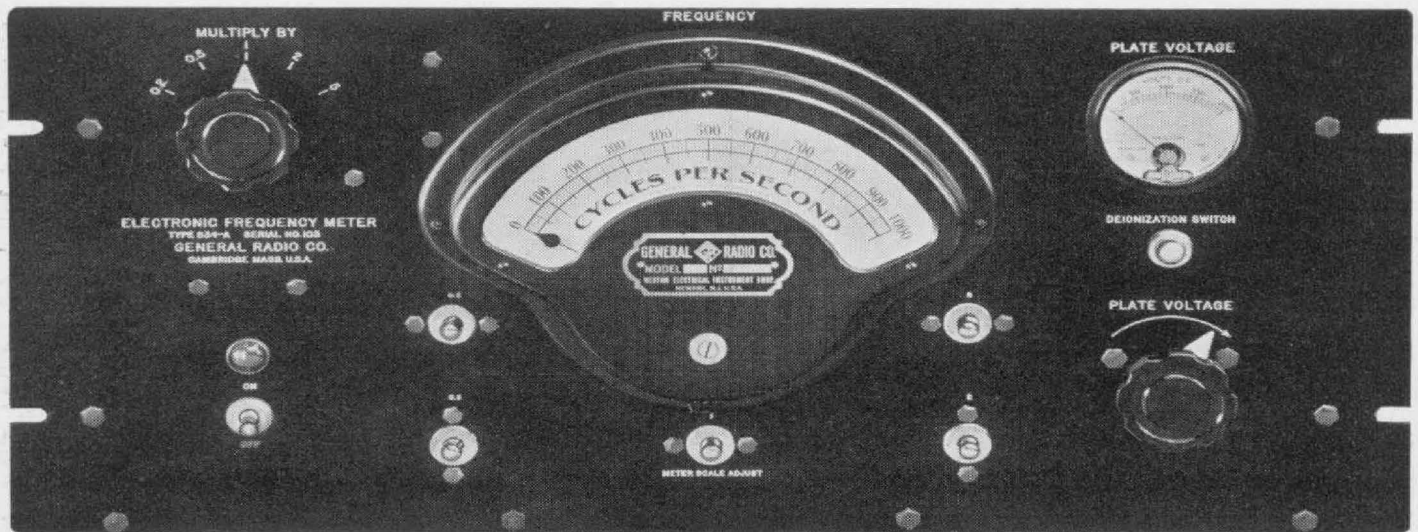

FIGURE 2. Panel view of TYPE 834-A Electronic Frequency Meter

value. Another example of this use is in tuning motor horns, chimes, and similar devices, where the continuous indication of the frequency is invaluable during the progress of adjustment.

When utilized with a sound or vibration pickup, the frequency meter is valuable in analyzing vibrations in machinery.

A simplified model of the electronic

frequency meter will shortly be available for use in monitoring radio transmitters. This instrument, the TYPE 682-A Frequency-Deviation Meter, is intended to operate in conjunction with the TYPE 475-A Frequency Monitor which furnishes the power supply for the frequency meter, as well as the audio-frequency beat tone on which the meter operates. —J. K. CLAPP

The TYPE 834-A Electronic Frequency Meter is available for immediate delivery. This instrument is manufactured and sold under the following U. S. Patents and license agreements:

Designs and patent applications of Dr. F. V. Hunt.

Patents of the American Telephone and Telegraph Company, solely for utilization in research, investigation, measurement, testing, instruction and development work in pure and applied science.

Type	Code Word	Price
834-A Electronic Frequency Meter . . .	MUCUS	\$250.00

THE General Radio EXPERIMENTER is mailed without charge each month to engineers, scientists, technicians, and others interested in communication-frequency measurement and control problems. When sending requests for subscriptions and address-change notices, please supply the following information: name, company name, company address, type of business company is engaged in, and title or position of individual.

GENERAL RADIO COMPANY
30 State Street - Cambridge A, Massachusetts

PRINTED
IN
U.S.A.